

Designation: Symbol:

Supplier: Supplier ArtNo.: Rev:

Manufacturer: Manufacturer ArtNo.:

Electrical data

Voltage [V]: Current [A]: Frequency [Hz]:

Ambient Temp [°C]: Battery backup: Total consumption [W]:

Luminaire description

Type: Light source: Consumption [W]:

Technology CC: CV: Trafo incl.: Illuminant incl.: Dimmable: No of illuminants:

CRI Index: Beam angle [°]: Colour temp [K]: Lum flux [lm]:

Mechanical description

Housing: Color: Prot. class: Fire class:

Reflector: Diffuser: Cover ring: Weight [kg]:

Surface height [mm]: Dimens. [mm] L: W: H: Ø: Cut out [mm]:

Rec. mnt. height [mm]: LED stripe cutting space [mm]: Delivery length [m]:

LED spacing [mm]: Lum. flux per metre [lm/m]: Bend. radius [mm]:

Mounting:

Equipment:

Power supply / Dimmer

Designation:

Prot. class: Dimension [mm] L: W: H: Ø: Weight [kg]:

Designation:

Prot. class: Dimension [mm] L: W: H: Ø: Weight [kg]:

Remarks:

Remarks:

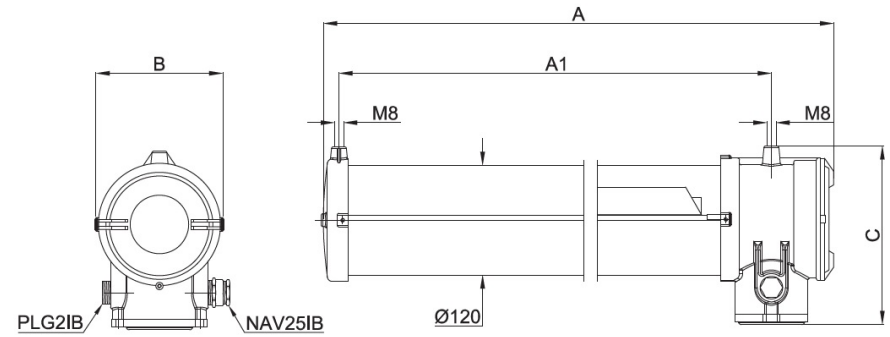
Code	Dimensions mm			
	A	A1	B	C
FLFE-101L	725	640	142	197